



EDUCAÇÃO

Brincar

Fichas de Comunicação Alternativa

Material complementar do guia *Arquitetura Infantil: reinventando os espaços*

Esse documento está organizado em duas partes: nas primeiras páginas, você encontrará os ícones agrupados no tamanho usual para a elaboração de prancha de Comunicação Alternativa. Nas páginas seguintes, você encontrará 71 fichas, cada uma com um ícone de Comunicação Alternativa em tamanho ampliado e seu nome escrito em português com fonte ampliado e contraste.

Além de usá-las para Comunicação Alternativa, você pode inventar brincadeiras e jogos como jogo da memória, mímica, adivinhação, dominó e o que mais a imaginação permitir.

Este material faz parte do Projeto Brincar, iniciativa da Fundação Grupo Volkswagen, concebido e implementado pela Mais Diferenças em parceria com a Secretaria Municipal de Educação de São Paulo.

Iniciativa

Parceiros



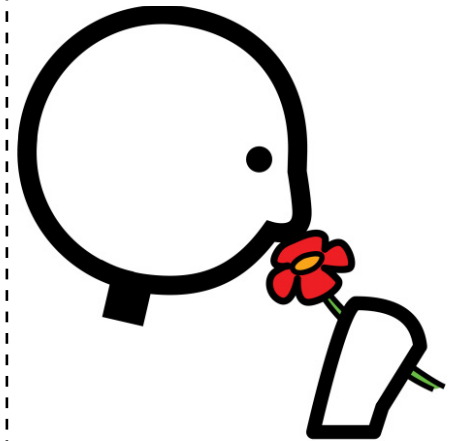
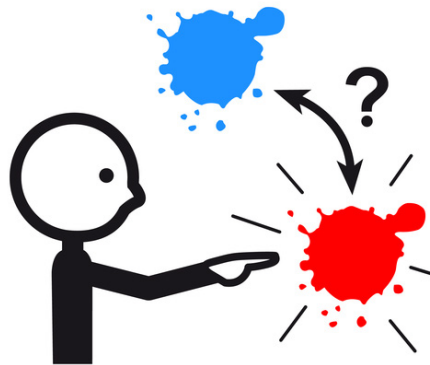
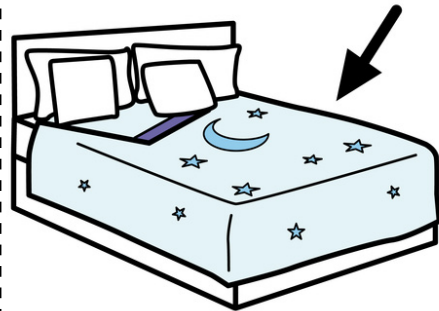
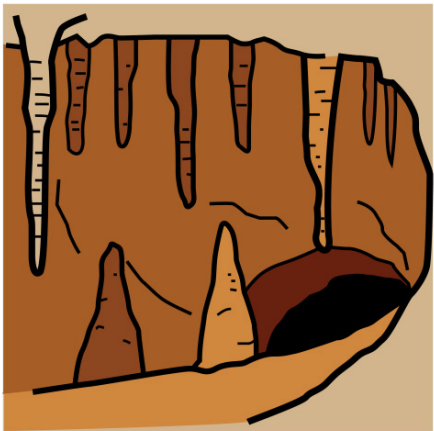
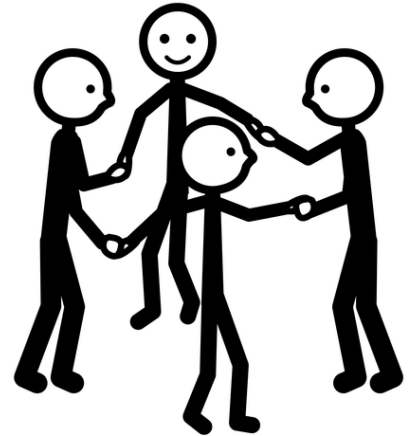
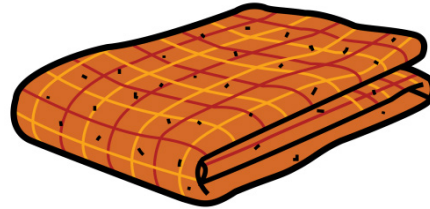
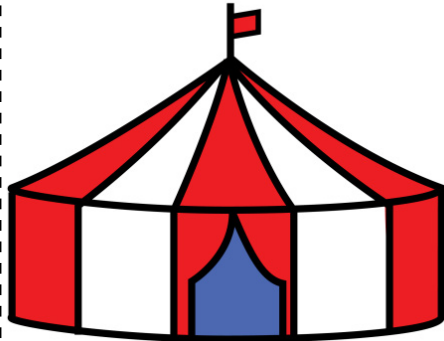
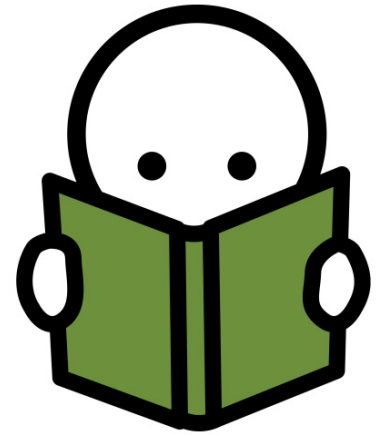
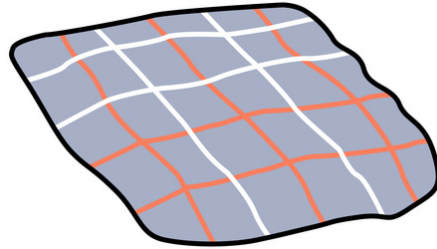

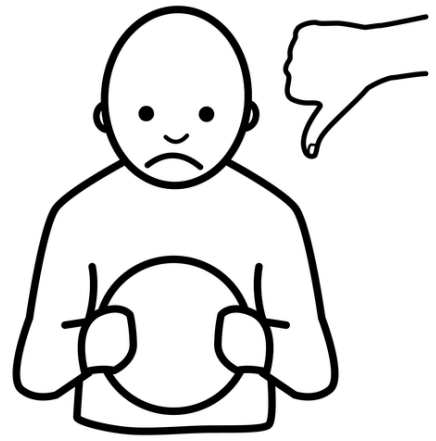
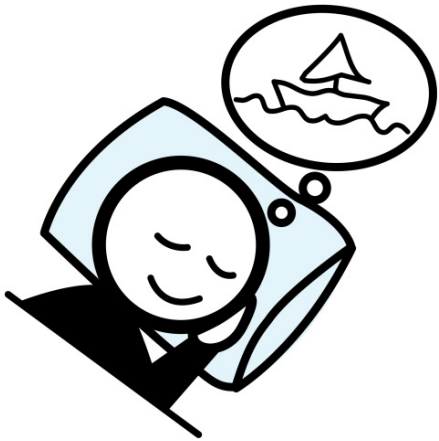
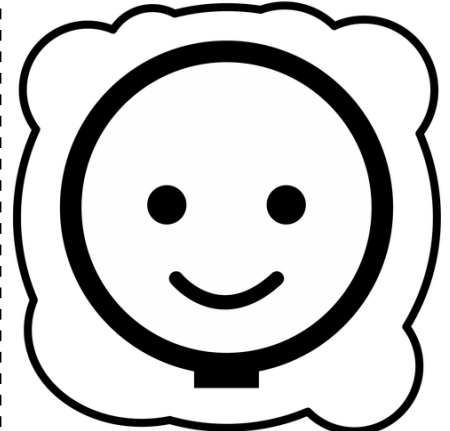
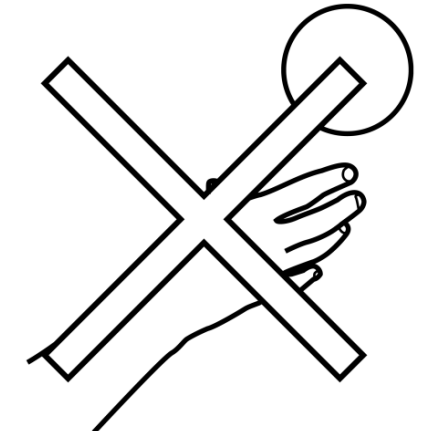
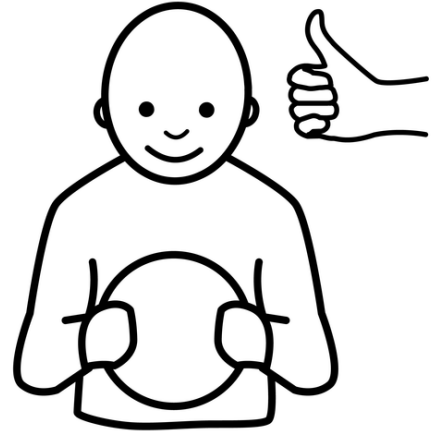
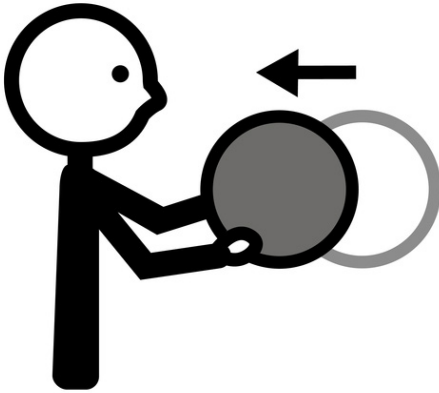
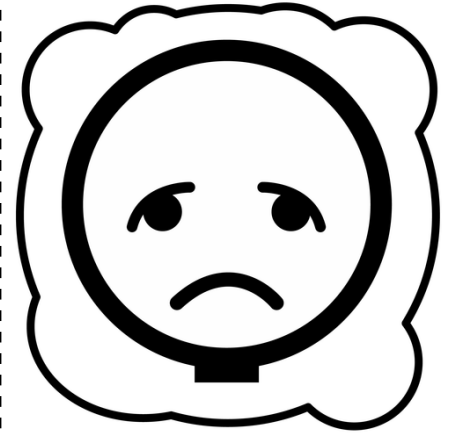
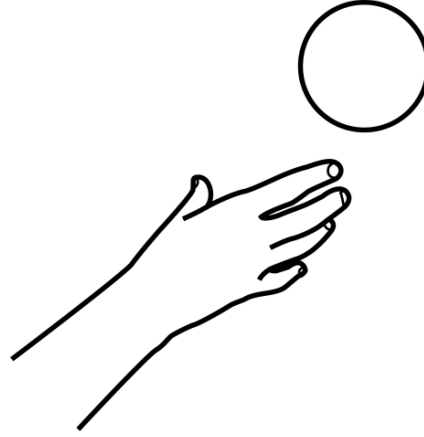
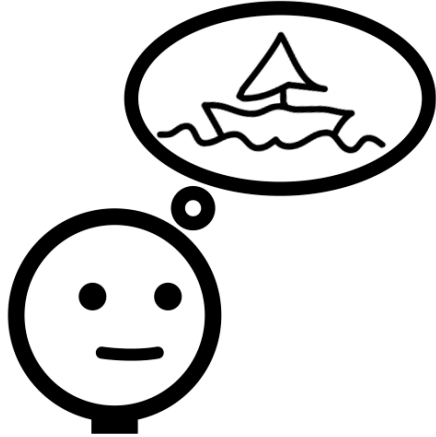
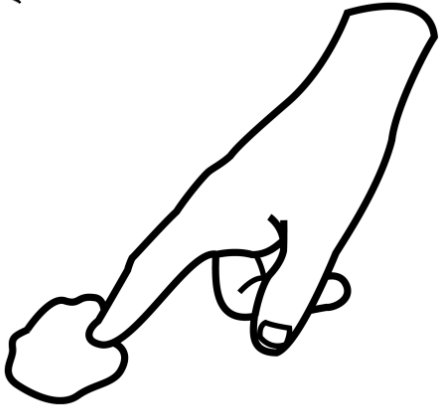

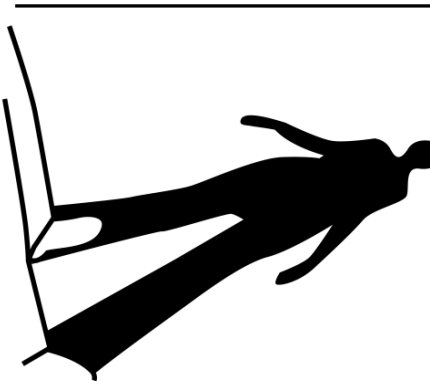
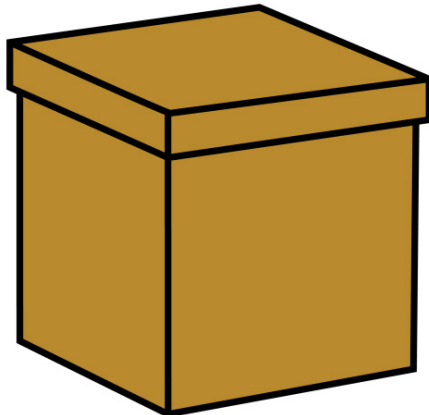
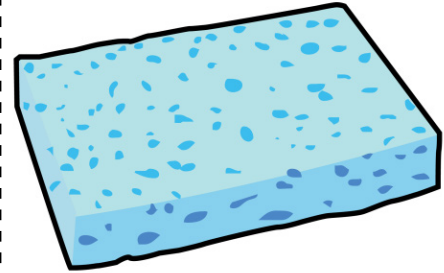
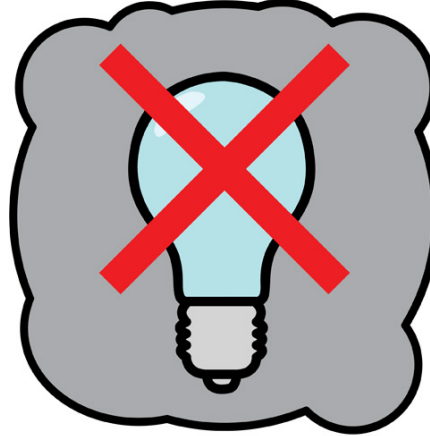
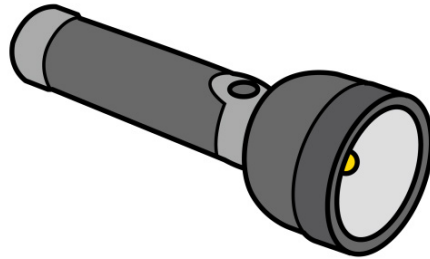
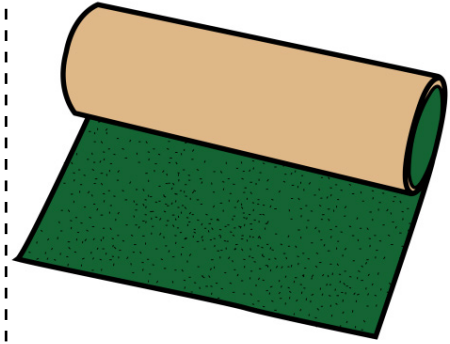
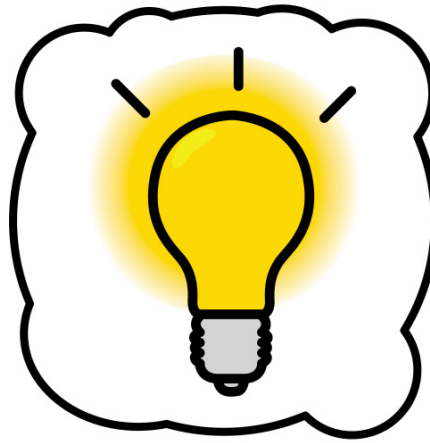
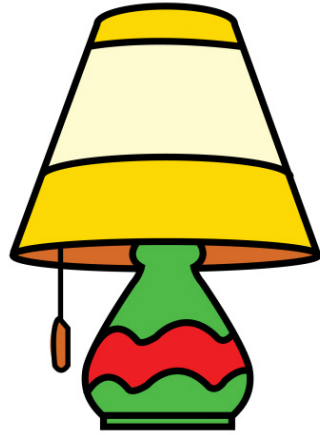
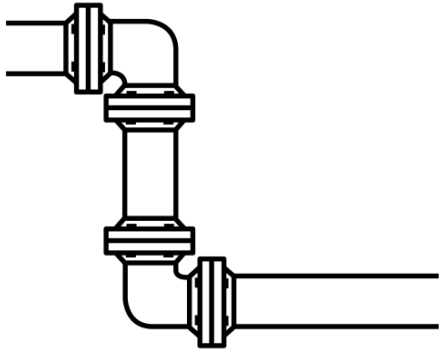

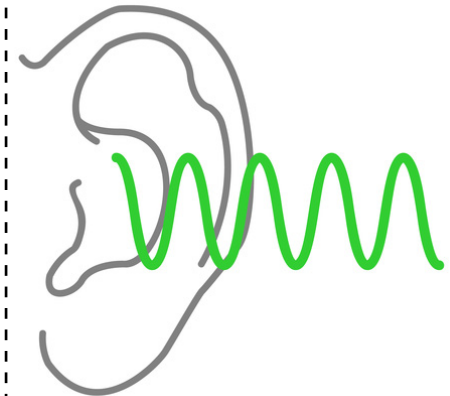
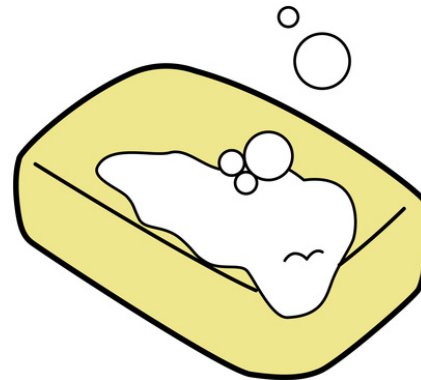
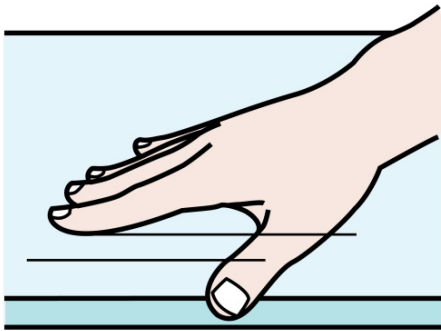
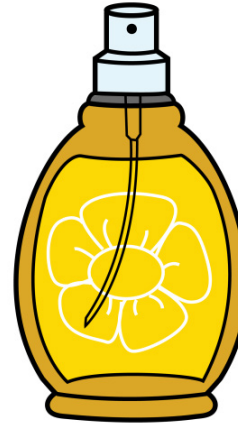
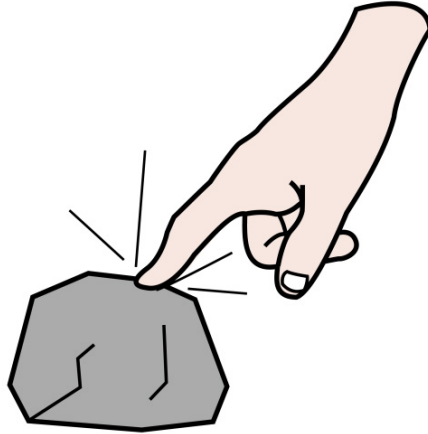
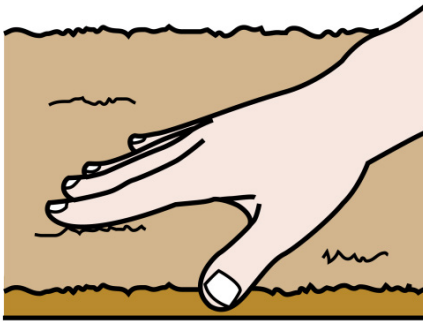
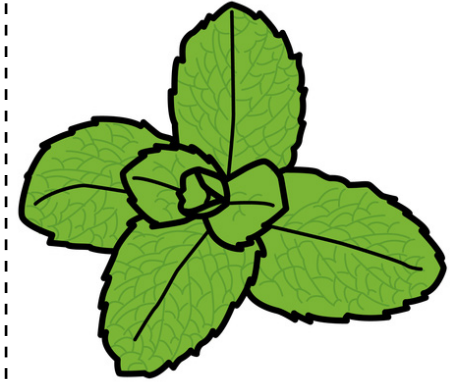
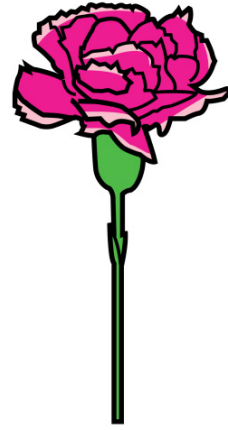
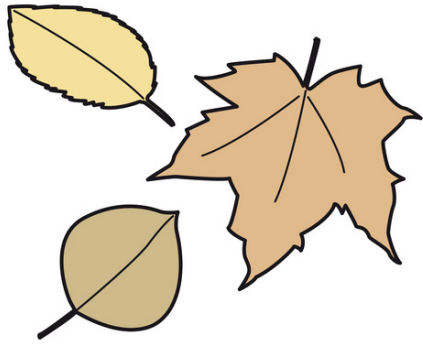

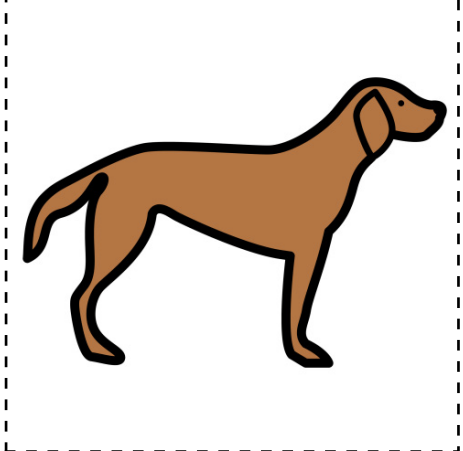
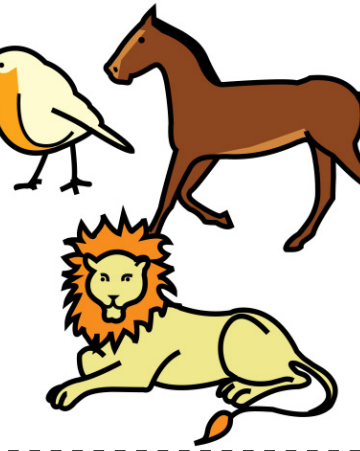
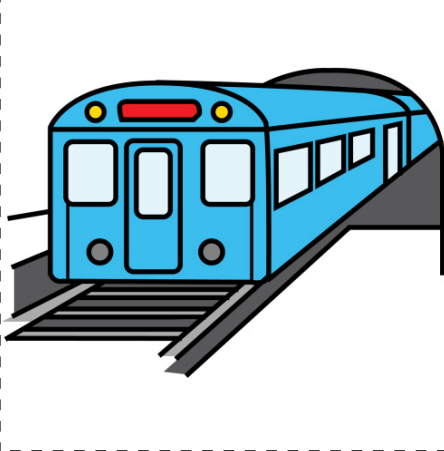
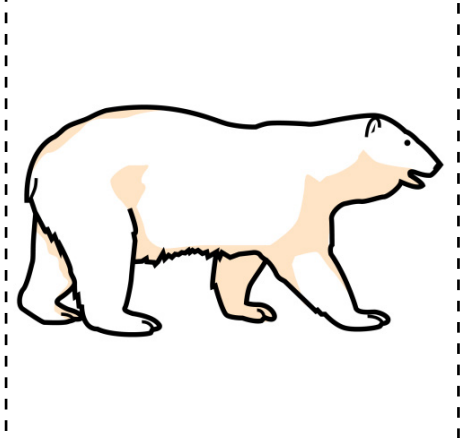
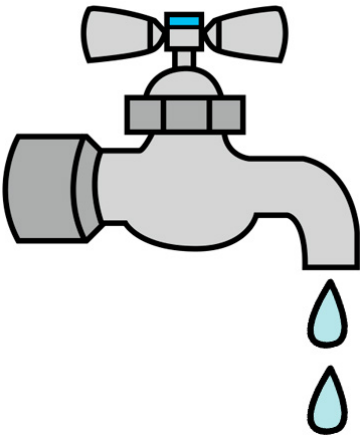
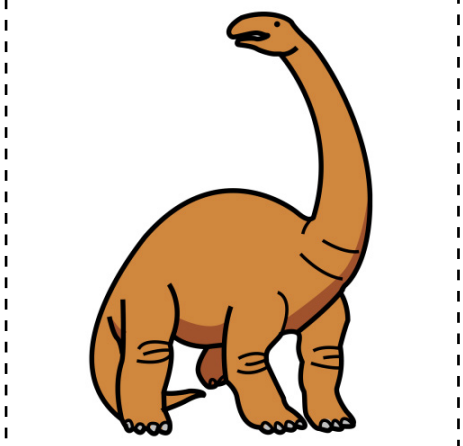
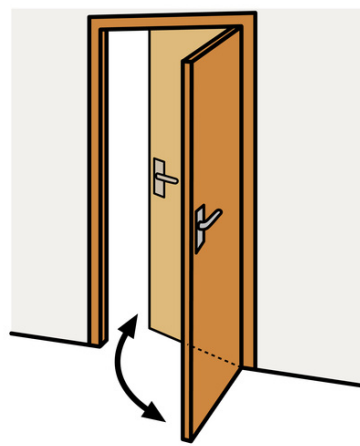
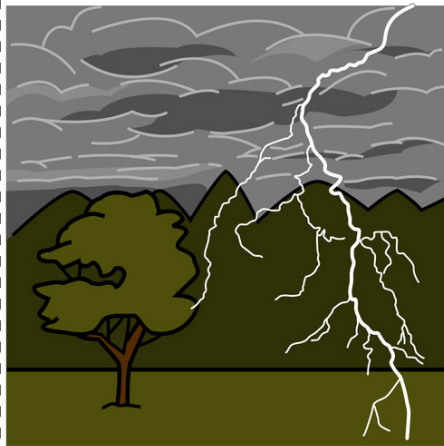

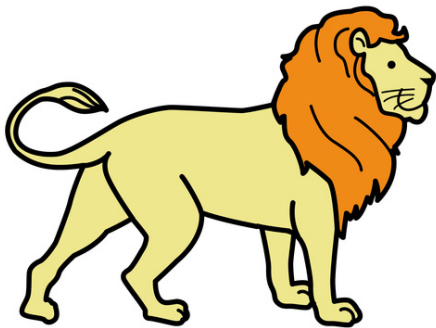
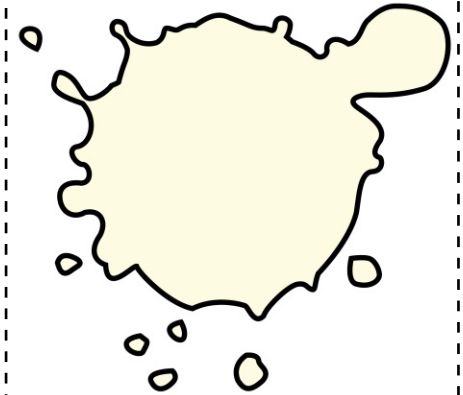
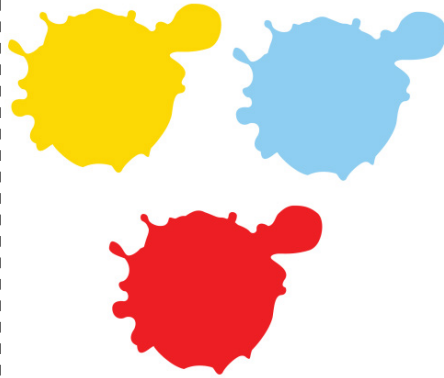
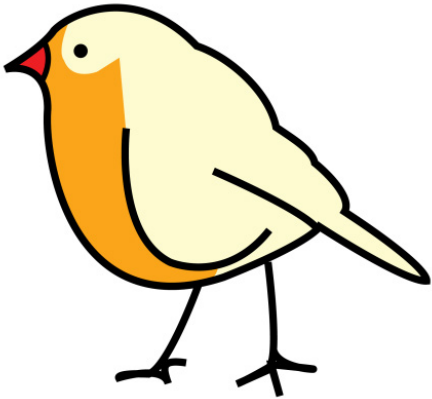
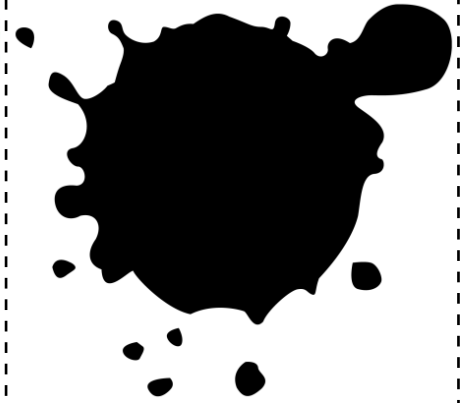
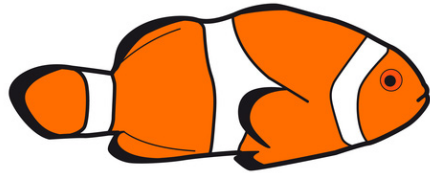
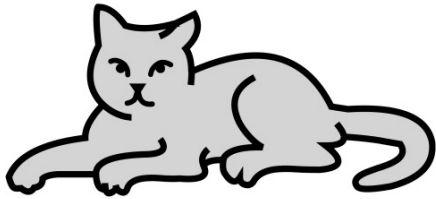

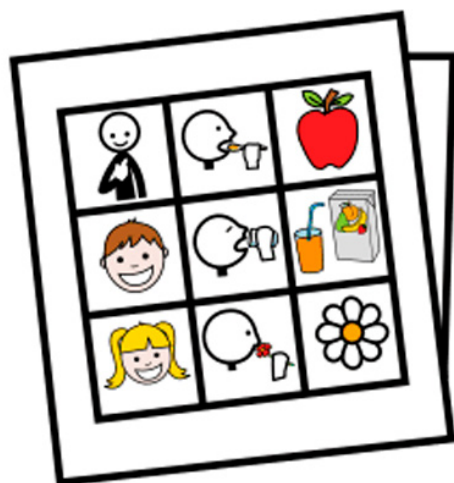

COMUNICAÇÃO ALTERNATIVA

Iniciativa

Parceiros

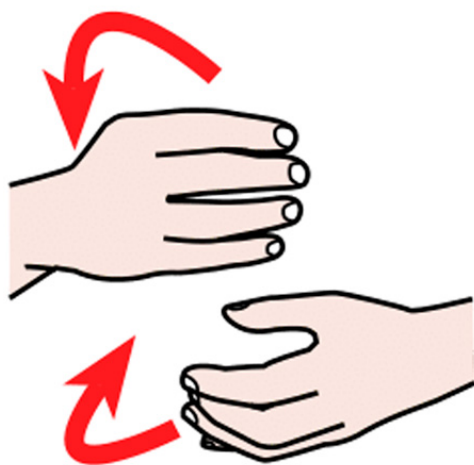

LIBRAS

Iniciativa

Parceiros

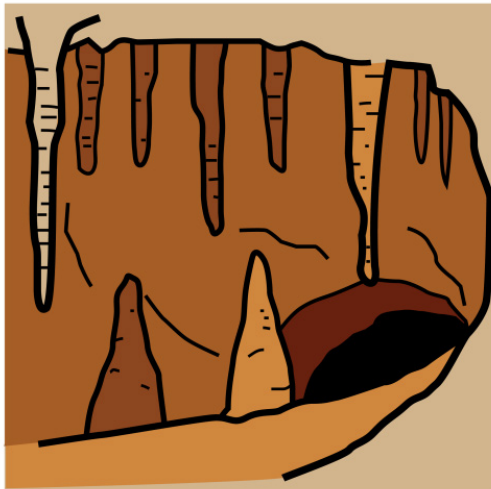

CAVERNA

Iniciativa

Parceiros



CABANA

Iniciativa

Parceiros

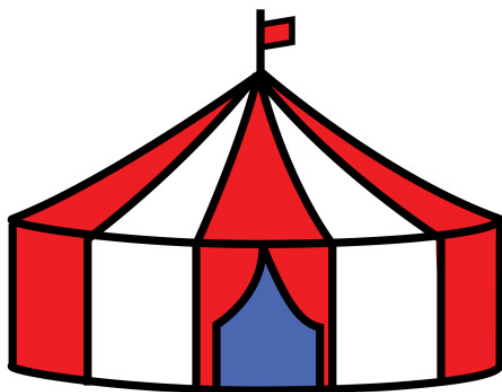

CIRCO

Iniciativa

Parceiros





LENÇOL

Iniciativa

Parceiros

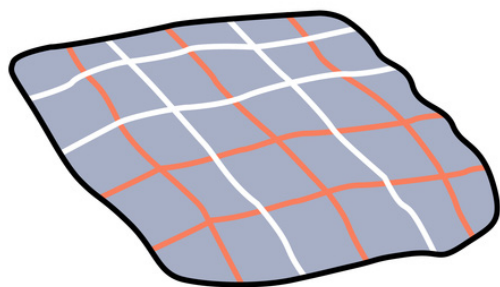

PANO

Iniciativa

Parceiros



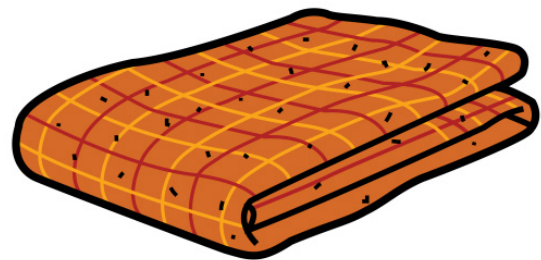

COBERTOR

Iniciativa

Parceiros

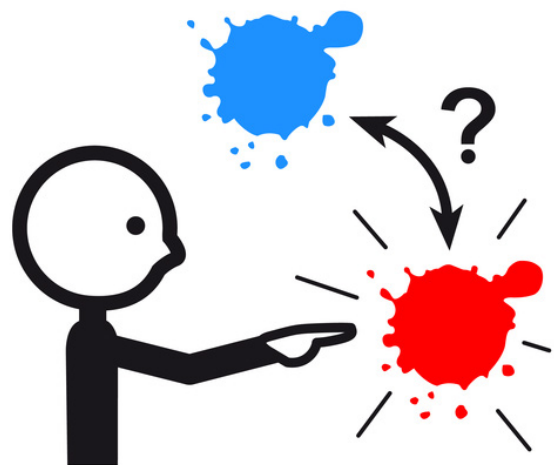

ESCOLHER

Iniciativa

Parceiros



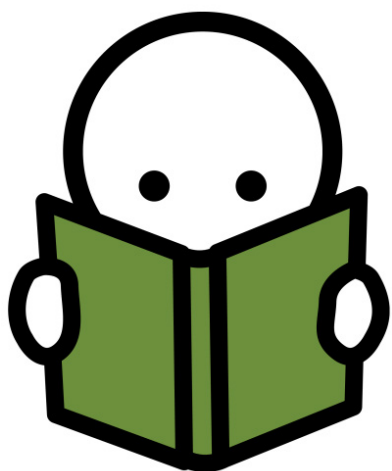

LER

Iniciativa

Parceiros



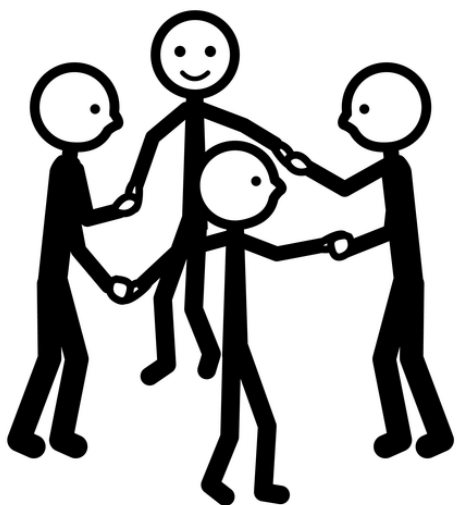

BRINCAR

Iniciativa

Parceiros



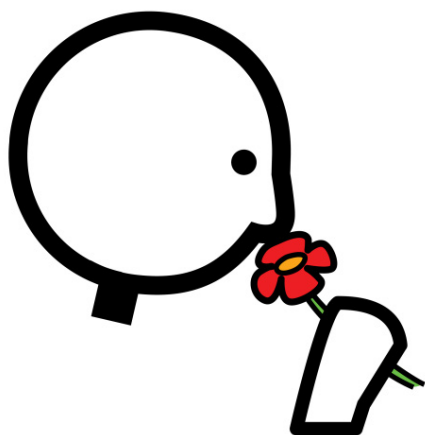

CHEIRAR

Iniciativa

Parceiros



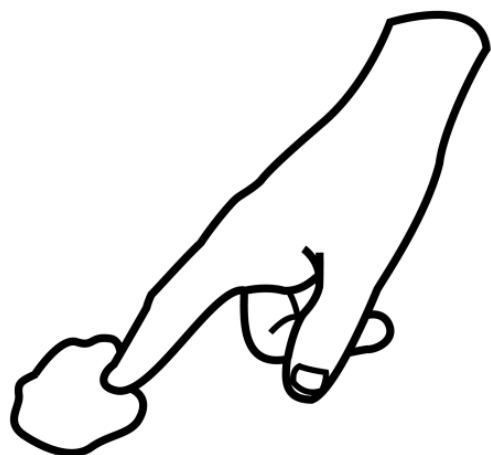

TOCAR

Iniciativa

Parceiros

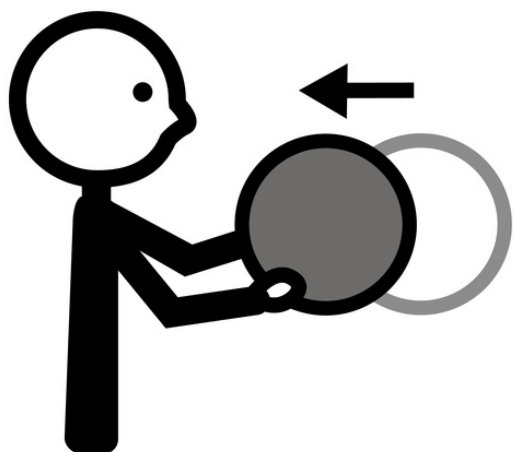

PEGAR

Iniciativa

Parceiros

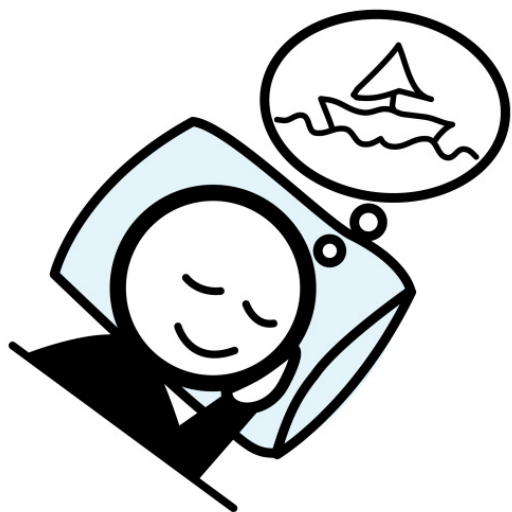

SONHAR

Iniciativa

Parceiros



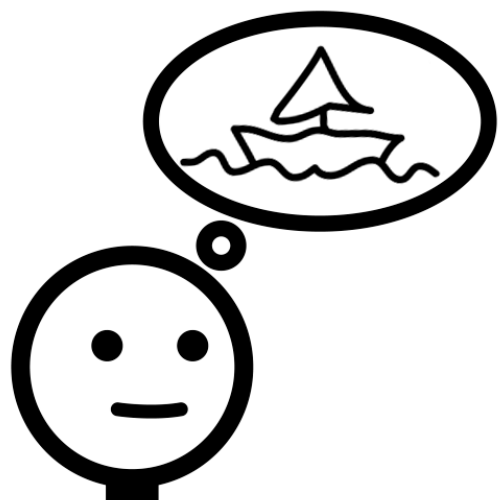

IMAGINAR

Iniciativa

Parceiros



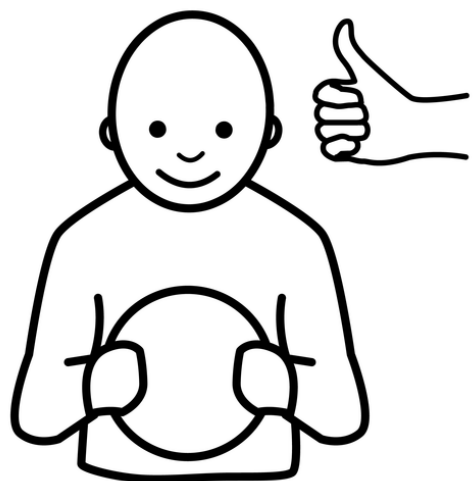

GOSTAR

Iniciativa

Parceiros

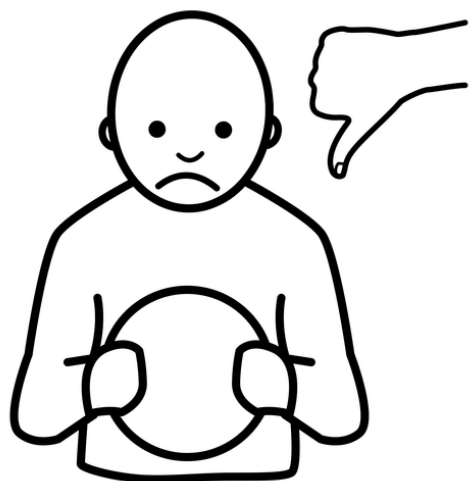

**NÃO
GOSTAR**

Iniciativa

Parceiros

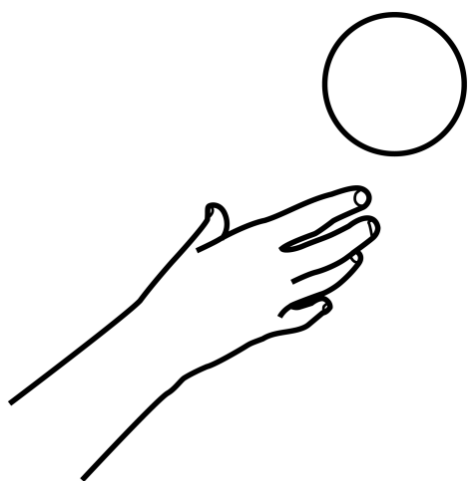

QUERER

Iniciativa

Parceiros



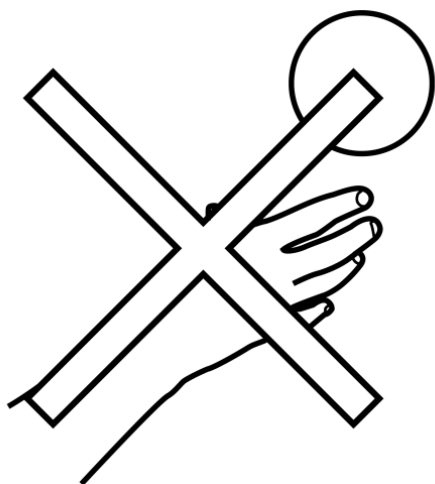

**NÃO
QUERER**

Iniciativa

Parceiros





MEDO

Iniciativa

Parceiros

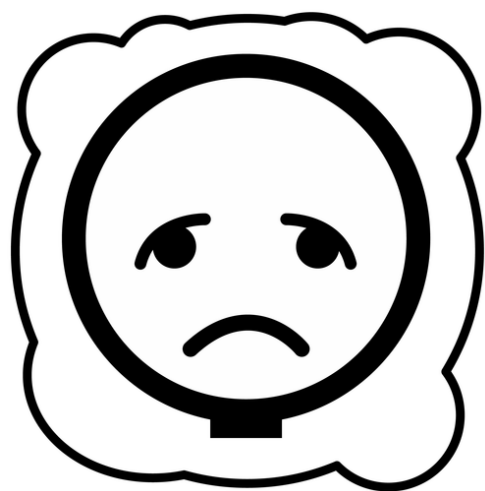

TRISTE

Iniciativa

Parceiros

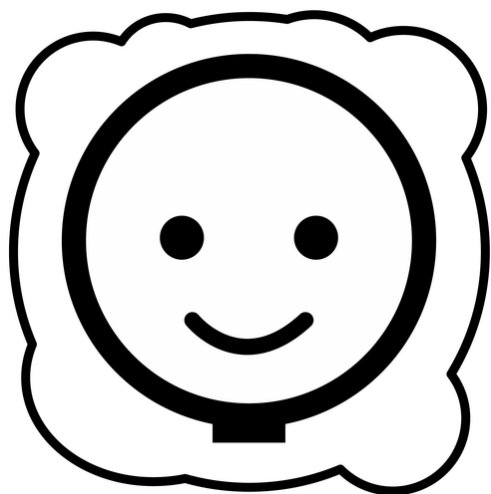

FELIZ

Iniciativa

Parceiros



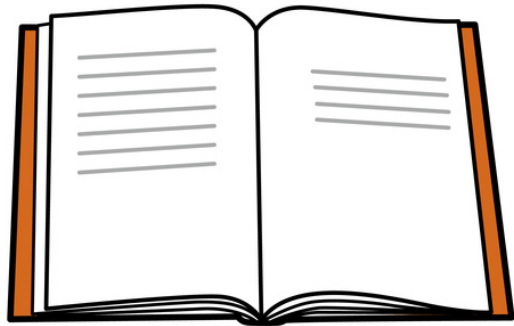

LIVRO

Iniciativa

Parceiros



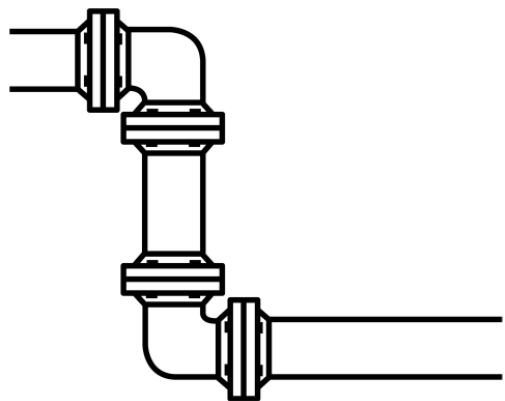

CANO

Iniciativa

Parceiros





BRINQUEDOS

Iniciativa

Parceiros

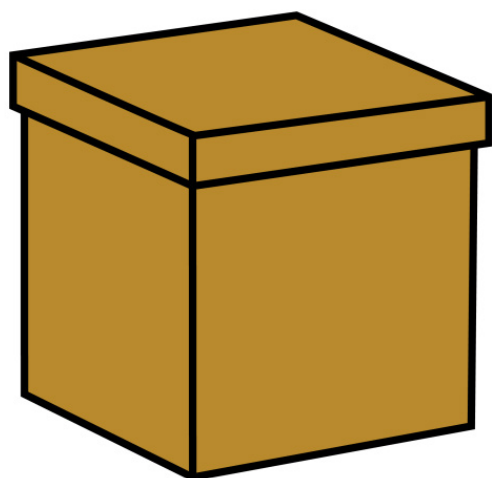

CAIXA

Iniciativa

Parceiros



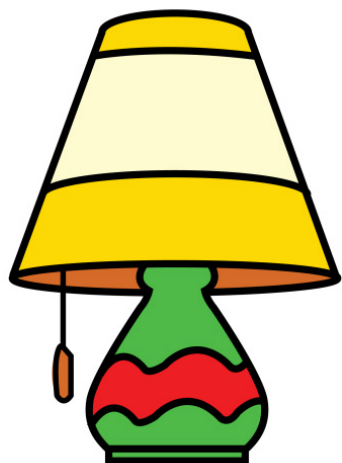

ABAJUR

Iniciativa

Parceiros

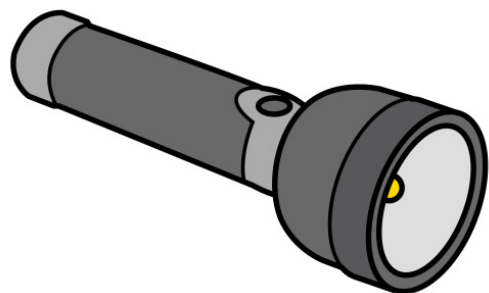

LANTERNA

Iniciativa

Parceiros





CELULAR

Iniciativa

Parceiros

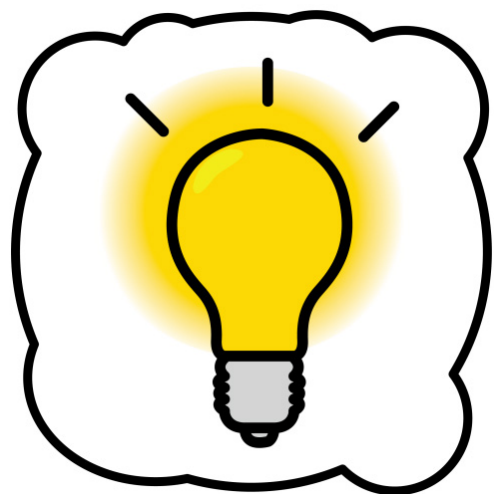

LUZ

Iniciativa

Parceiros



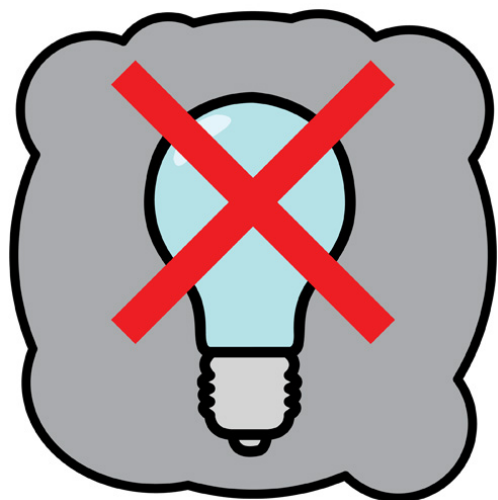

ESCURO

Iniciativa

Parceiros

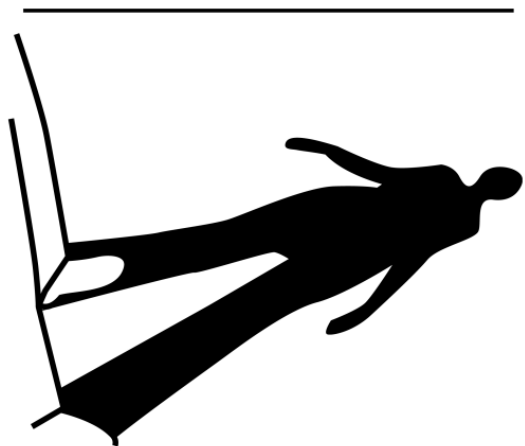

SOMBRA

Iniciativa

Parceiros



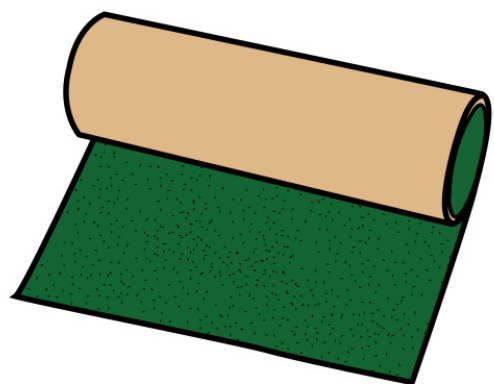

LIXA

Iniciativa

Parceiros

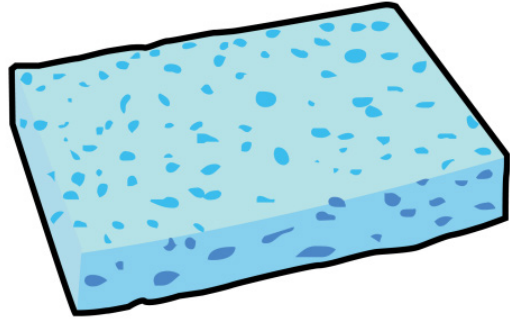

ESPONJA

Iniciativa

Parceiros





ALGODÃO

Iniciativa

Parceiros



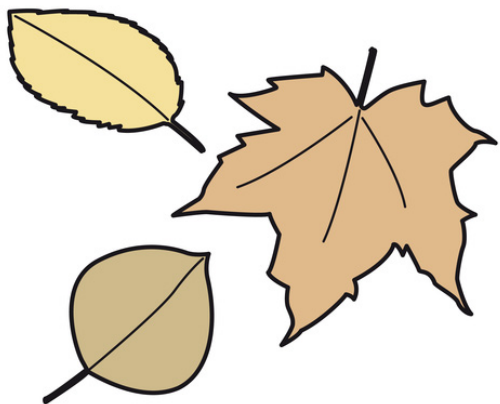

FOLHA SECA

Iniciativa

Parceiros



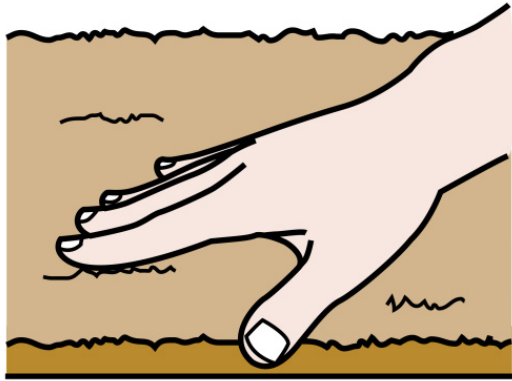

ÁSPERO

Iniciativa

Parceiros

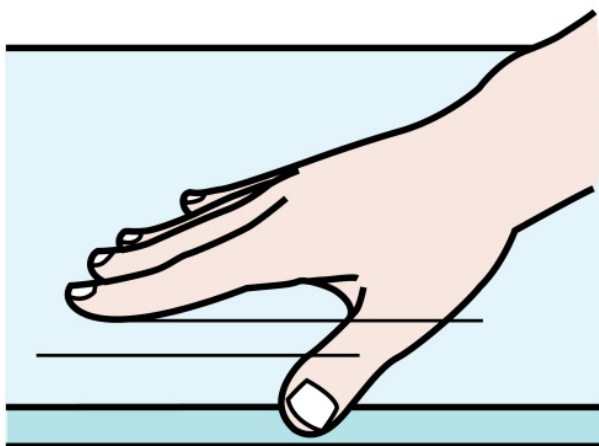

LISO

Iniciativa

Parceiros



MACIO

Iniciativa

Parceiros

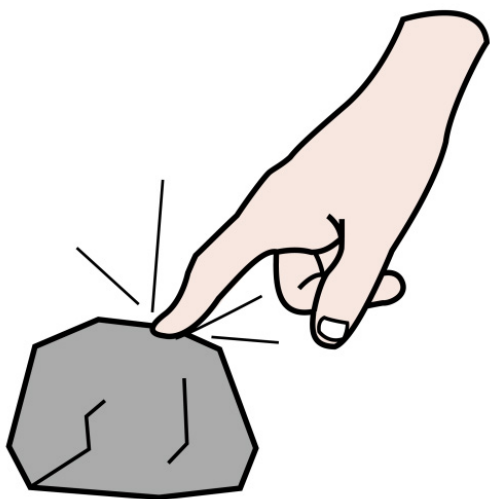

DURO

Iniciativa

Parceiros



CANELA

Iniciativa

Parceiros

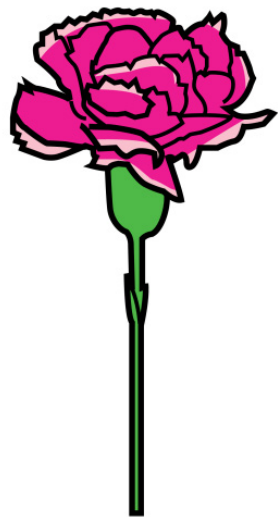

FLOR

Iniciativa

Parceiros



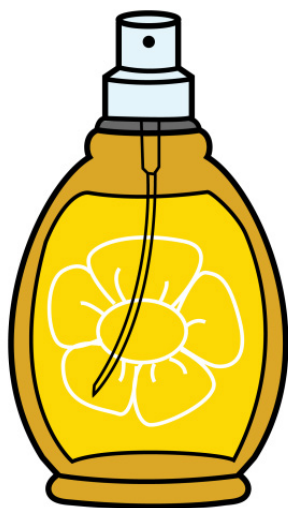

PERFUME

Iniciativa

Parceiros



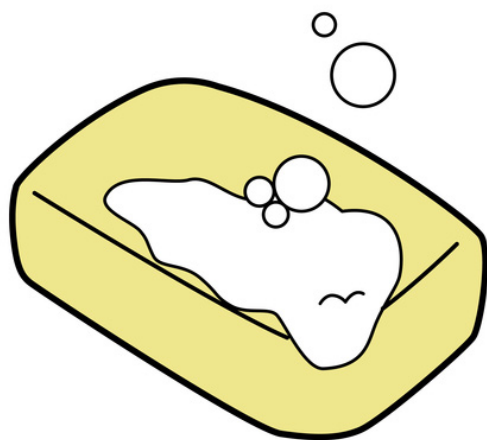

SABONETE

Iniciativa

Parceiros





HORTELÃ

Iniciativa

Parceiros





CAFÉ

Iniciativa

Parceiros



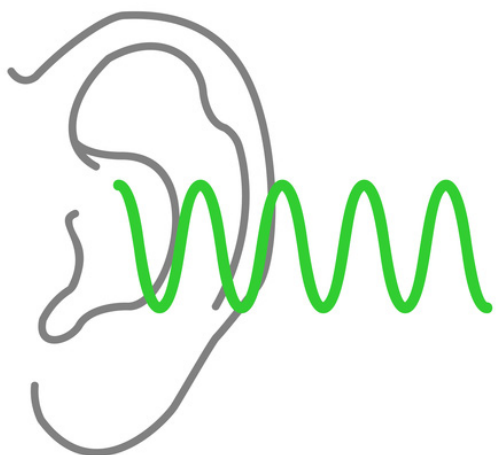

BARULHO

Iniciativa

Parceiros



ONDAS DO MAR

Iniciativa

Parceiros





VENTO

Iniciativa

Parceiros



CHUVA

Iniciativa

Parceiros



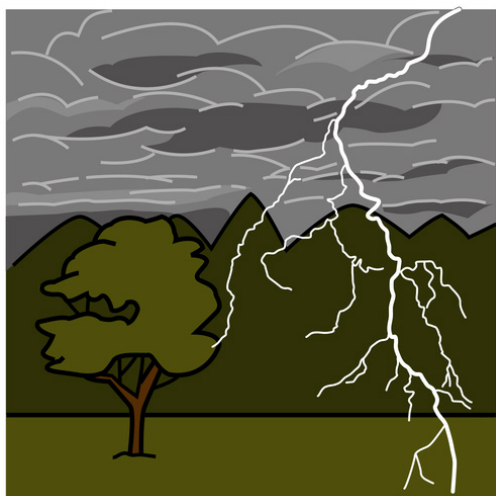

TROVÃO

Iniciativa

Parceiros





BUZINA DE CARRO

Iniciativa

Parceiros

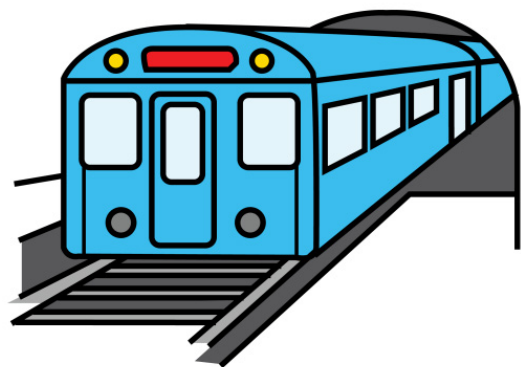

TREM

Iniciativa

Parceiros



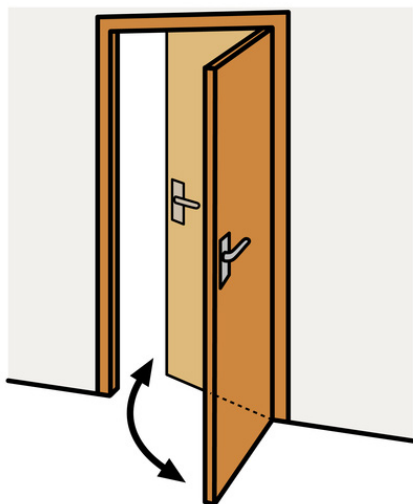

PORTA BATENDO

Iniciativa

Parceiros

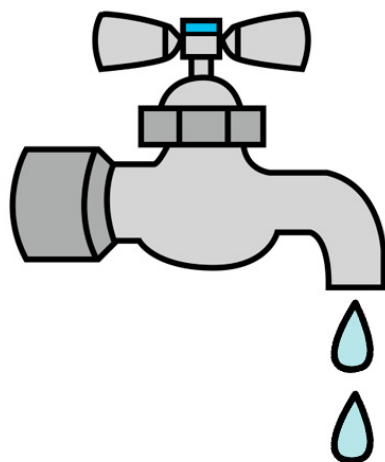

ÁGUA PINGANDO

Iniciativa

Parceiros

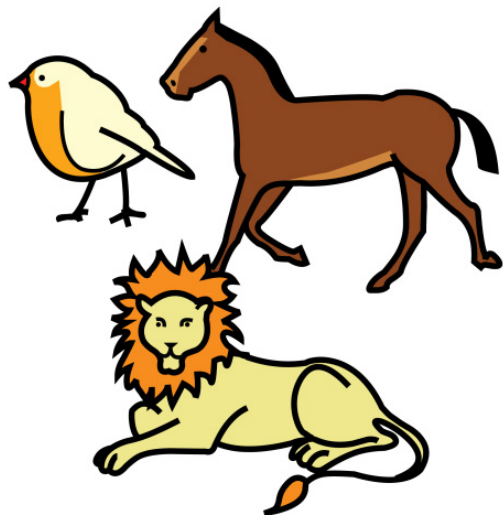

ANIMAIS

Iniciativa

Parceiros



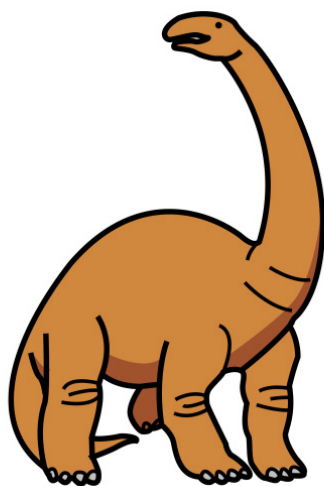

DINOSSAURO

Iniciativa

Parceiros



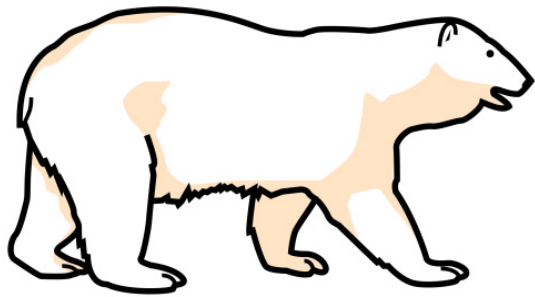

URSO

Iniciativa

Parceiros



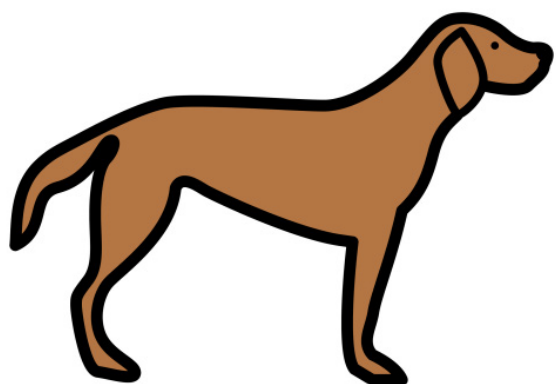

CACHORRO

Iniciativa

Parceiros

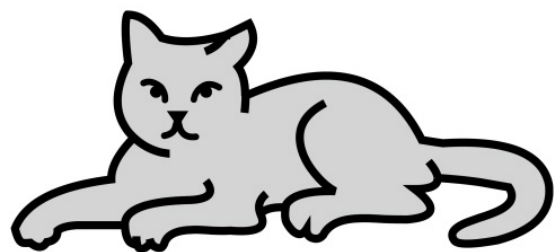

GATO

Iniciativa

Parceiros



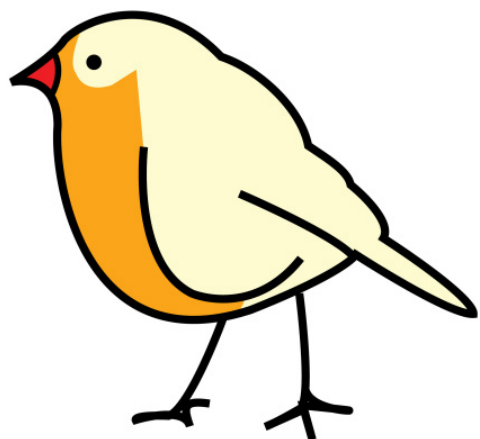

PASSARINHO

Iniciativa

Parceiros



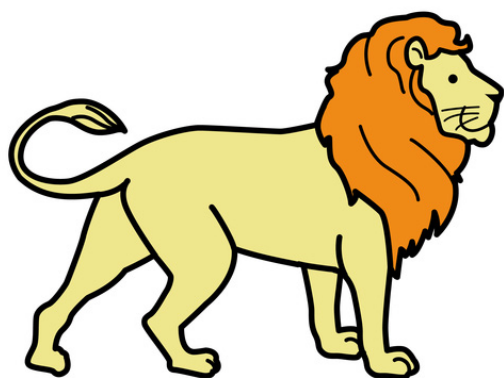

LEÃO

Iniciativa

Parceiros



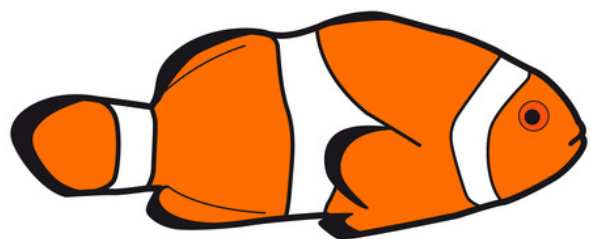

PEIXE

Iniciativa

Parceiros



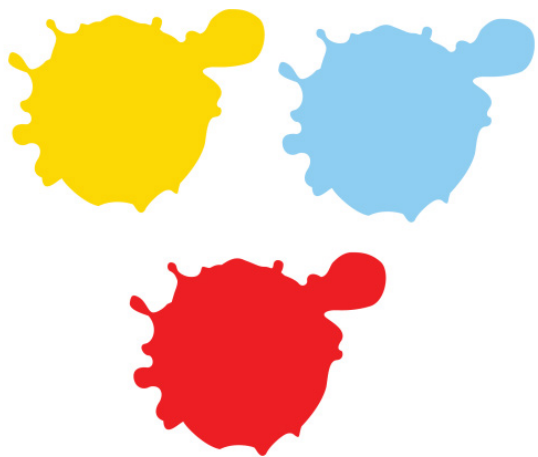

CORES

Iniciativa

Parceiros





VERMELHO

Iniciativa

Parceiros





AZUL

Iniciativa

Parceiros





VERDE

Iniciativa

Parceiros





AMARELO

Iniciativa

Parceiros





PRETO

Iniciativa

Parceiros



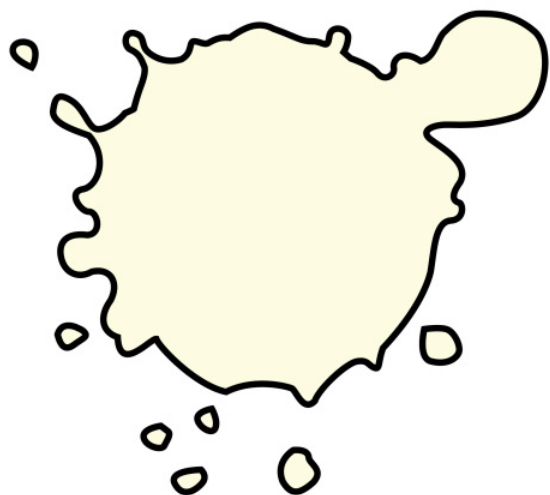

BRANCO

Iniciativa

Parceiros



Sobre o Projeto Brincar

O Projeto Brincar é uma iniciativa da Fundação Grupo Volkswagen em parceria com a Secretaria Municipal de Educação de São Paulo, concebida e desenvolvida pela Mais Diferenças. Desde 2017, o Projeto propõe a criação e experimentação de práticas pedagógicas inclusivas de maneira a contribuir com a qualidade das políticas públicas de Educação Infantil ofertadas a todas as crianças, com e sem deficiência. Em 2020, o Brincar foi reconhecido em âmbito internacional pela iniciativa Zero Project, que premia práticas inovadoras voltadas à garantia dos direitos das pessoas com deficiência no mundo. Para saber mais sobre o Projeto, acesse:

<https://fundacaogrupovw.org.br/projetos/brincar/>

<https://educacao.sme.prefeitura.sp.gov.br/projeto-brincar-oferece-formacaocontinuada-aos-educadores-da-educacao-infantil/>

<http://maisdiferencas.org.br/projeto/brincar/>